

19" Rack Mountable 4 Fans Cooling Module



Table of Content

1.	Introduction.....	Page 5
2.	Main Features.....	Page 5
3.	Product Numbers.....	Page 5
4.	Product Content.....	Page 6
5.	Connections and Features.....	Page 7
5.1.	Front Side.....	Page 7
5.1.1.	Green LED.....	Page 7
5.1.2.	Red LED.....	Page 7
5.1.3.	Display with Control Buttons.....	Page 7
5.1.4.	ON/OFF Switch.....	Page 7
5.2.	Rear Side.....	Page 8
5.2.1.	Grounding M4.....	Page 8
5.2.2.	Power Input.....	Page 8
5.2.3.	Sensor Controlled Power Outputs.....	Page 8
5.2.4.	Auxiliary Power Outputs.....	Page 8
6.	Product Variants and Configurations.....	Page 9
6.1.	D1000XXX - 19" Rack Mountable 4 Fans Cooling Module V1.....	Page 9
6.2.	D1000968 – 19" Rack Mountable 4 Fans Cooling Module V2.....	Page 9
6.3.	D1000968 – 19" Rack Mountable 4 Fans Cooling Module V3.....	Page 9
6.4.	D1000968 – 19" Rack Mountable 4 Fans Cooling Module V4.....	Page 9
7.	Dimensions.....	Page 10
8.	Installation.....	Page 11
9.	Programming the 19" Rack Mountable 4 Fans Cooling Module.....	Page 12
9.1.	Definitions.....	Page 12
9.1.1.	Buttons.....	Page 12
9.1.2.	Selection mode.....	Page 12
9.1.3.	Output channels.....	Page 12
9.1.4.	Display.....	Page 12
9.2.	Programming the different versions.....	Page 13
9.2.1.	Programming 19" Rack Mountable 4 Fans Cooling Module V1.....	Page 13
A.	SETUP THE SENSORS 1,2,3 and 4 WITH CORRESPONDING OUTPUT.....	Page 13
9.2.2.	Programming 19" Rack Mountable 4 Fans Cooling Module V2.....	Page 14
A.	SETUP THE SENSORS 1,2,3 and 4 WITH CORRESPONDING OUTPUT.....	Page 14
B.	SETUP SAFETY TEMPERATURE.....	Page 15
9.2.3.	Programming 19" Rack Mountable 4 Fans Cooling Module V3.....	Page 16
A.	SETUP THE SENSORS 1,2,3 and 4 WITH CORRESPONDING OUTPUT.....	Page 16
B.	SETUP SAFETY TEMPERATURE.....	Page 17
9.2.4.	Programming 19" Rack Mountable 4 Fans Cooling Module V4.....	Page 18
A.	SETUP THE SENSORS 1,2,3 and 4 WITH CORRESPONDING OUTPUT.....	Page 18
10.	LED Indicators.....	Page 19
11.	Buzzer.....	Page 19
12.	Trouble Shooting.....	Page 19
13.	Technical Specifications.....	Page 20
14.	Environmental and Recycling.....	Page 20
15.	Packaging.....	Page 20
16.	Acoustics.....	Page 20
17.	Power Cords.....	Page 20
18.	Optional Products.....	Page 21

Acknowledgments

All names, brands, products, or services are trademarks or registered trademarks of their respective companies.

Notices.

The information in this document is subject to change without notice. While every effort has been made to ensure that all information in this document is accurate, the authors accept no liability for any errors that may arise. No part of this document may be transmitted or copied in any form, or by any means, for any purpose, without the written permission of the authors.
Issue 1.0 December 09, 2023

What is in this guide?

This user guide gives you step-by-step instructions on how to install, configure and connect the 19" Rack Mountable Cooling Module B-Series, and how to use and maintain the system.

Who should use this guide?

This user guide assumes that you have a working knowledge environment into which you are installing the 19" Rack Mountable Cooling Module. If you do not have these skills or are not confident with the instructions in this guide, request assistance to proceed with the installation.

<p>Safety</p> <p>Observe physical, electrical, and electronic component safety precautions.</p> <p>Permanently unplug the unit if you think that it has become damaged in any way and before you move it.</p> <p>CAUTION: This equipment must be used in the manner specified in this document and any related documentation. Failure to do so may bypass the protection provided by the equipment. Damage If you think the equipment is damaged in any way, remove all external cords and cables, and contact your equipment supplier.</p> <p>CAUTION: To comply with applicable safety, emission, and thermal requirements no covers should be removed.</p> <p>CAUTION: Hot air may blow from the front of the module.</p> <p>DANGER: Power outputs could be under voltage. Do not touch any power output nor try to put any metal part inside the connectors. It is the responsibility of the customer to ensure that the device is grounded to prevent an electrical shock.</p> <p>DANGER: Multiple power cords. The product might be equipped with multiple power cords. Remove all hazardous voltages, disconnect all power cords prior to handling the device.</p> <p>Power Supply Safety Davantronic 19" Rack Mountable Cooling Modules must only be operated from an AC power supply input voltage range of: 100/120VAC or 220/240VAC.</p>	<p>AC PSU Safety Precautions</p> <ul style="list-style-type: none"> ◆ The power cord/cable on the power input is used as the main disconnect device. Ensure that the socket outlets are located near the equipment and are easily accessible. ◆ Disconnect all supply power for complete isolation. ◆ The power connection must always be disconnected prior to removal and handling of the device ◆ Check the grounding of the enclosure before applying power. ◆ Provide a suitable power source with electrical overload protection to meet the requirements laid down in the technical specification. <hr/> <p>CAUTION: Do not remove covers from the device. Danger of electric shock inside. Return the device to the supplier for repair.</p> <hr/> <p>CAUTION: If this equipment is used in a manner not specified by the manufacturer, the protection provided by the equipment may be impaired.</p> <p>Rack System Precautions</p> <p>The following safety requirements must be considered when the enclosure is mounted in a rack.</p> <ul style="list-style-type: none"> ◆ The rack design should incorporate stabilizing features suitable to prevent the rack from tipping or being pushed over during installation or in normal use. ◆ Do not slide more than one enclosure out of the rack at one time to avoid the danger of the rack toppling over. 	<ul style="list-style-type: none"> ◆ Always remove all modules and drives to minimize weight before loading chassis into a rack. ◆ When loading a rack with the units, fill the rack from the bottom up and empty from the top down. ◆ The rack design should take into consideration the maximum operating ambient temperature for the unit, which is 40°C (104°F) when two power supply modules are fitted. ◆ The rack should have a safe electrical distribution system. It must provide overcurrent protection for the enclosure and must not be overloaded by the total number of enclosures installed in the rack. Consideration of the chassis name plate rating should be used when addressing these concerns. ◆ The electrical distribution system must provide a reliable earth for each unit and the rack. ◆ Always use the correct air intake front plate and install it as described in the documentation ◆ The rack when configured with the enclosures must meet the safety requirements of UL 60950-1 and IEC 60950-1/EN 60950-1.
--	---	--

1. Introduction: 19" Rack Mountable 4 Fans Cooling Module

Congratulations on acquiring the Davantronic 19" Rack Mountable 4 Fans Cooling Module. This device is the perfect solution to keep the temperature in your 19" rack in balance. Furthermore, it is intended to turn 4 outputs ON or OFF based on their corresponding NTC temperature sensor input. The module has 1 extra output (output 5) which is intended to turn ON or OFF a 220V AC power output circuit.

2. Main Features

ALUMINIUM FRAME

Features an extruded aluminum frame with a sand blasted black finish give the device a clean and professional look.

EXTERNAL EXPANSION SENSORS

Depending on the configuration, there up to 3 expansion sensor ports available to measure temperature on different locations and control expansion ventilation modules

SMART DISPLAY CONTROL MODULE

For temperature monitoring, thermal control, programming power outputs to auxiliary cooling modules and Safety temperature output.

EXPANSION VENTILATION MODULES

Depending on the configuration there are up to 3 external expansion power outputs to connect and operate additional ventilation modules.

THERMAL SENSOR INSIDE

All devices have an internal NTC sensor that reads the temperature from outside the device

SAFETY TEMPERATURE SET-UP

To control the auxiliary power outputs. When the temperature of a given sensor reaches the safety temperature, the auxiliary power outputs will turn off. This is to protect the electronic equipment.

3. Product Numbers

Product Number	Description	Input Voltage (V AC)	
D1000737	19" Rack Mountable 4 Fans Cooling Module V1-1	110	220
D1000697	19" Rack Mountable 4 Fans Cooling Module V2-1	110	220
D1000738	19" Rack Mountable 4 Fans Cooling Module V3-1	110	220
D1000736	19" Rack Mountable 4 Fans Cooling Module V4-1	110	220

Ordering code: Product Number-Input Voltage -> example D1000737-220

4. Product Content

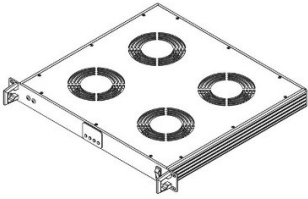
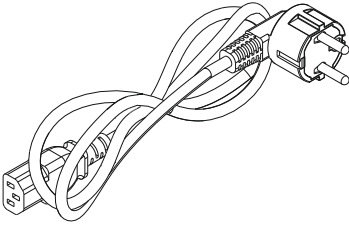
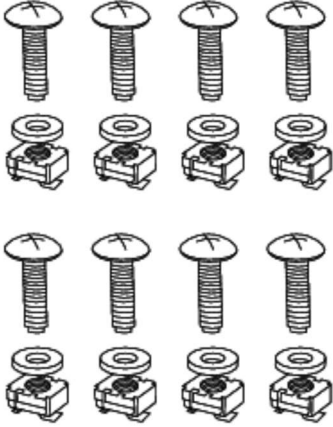
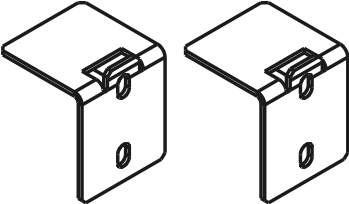
<p>Cooling Module (1x)</p> 	<p>Power Cord (1x)</p> 	<p>Mounting screws and Nuts (8x)</p> 
<p>Support Brackets (2x)</p> 		

5. Connections and features

5.1. Front Side

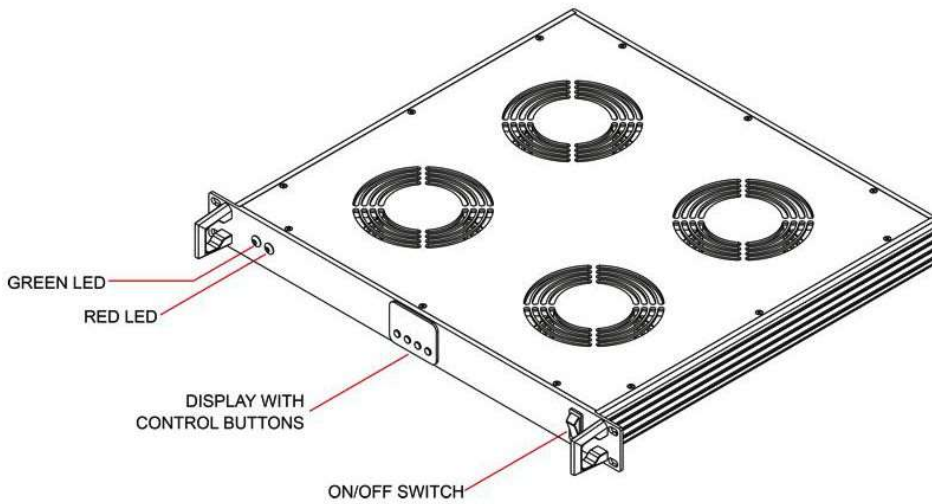

5.1.1. Green LED:

The green LED lights up when the device turns on. It will remain green as long as the device works properly.

5.1.2. Red LED:

The red LED lights up when the given maximum temperature for a sensor has been reached.

5.1.3. Display with Control Buttons:

Temperature Indication:

- Displays the temperature of each sensor.
- Displays the high and low temperatures during set-up.

High / Low Temperature

Displayed when setting up the high and low limits during programming.

- **H**: The temperature at which the fans turn on
- **L**: The temperature at which the fans turn off after cooling

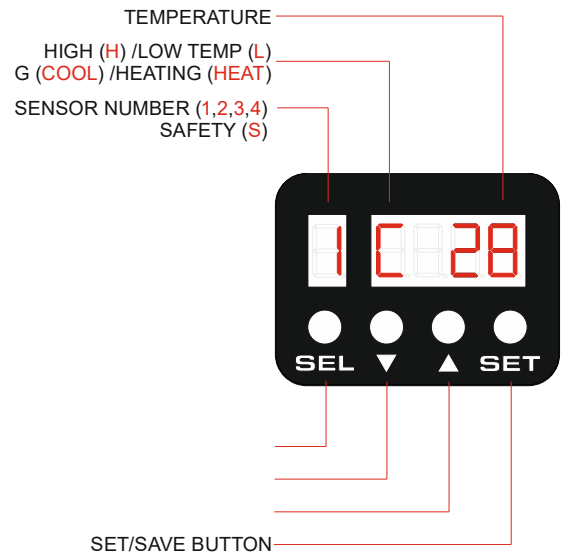

5.1.4. ON/OFF Switch:

Use the ON/OFF switch to turn the device ON or OFF.

5.2. Rear Side

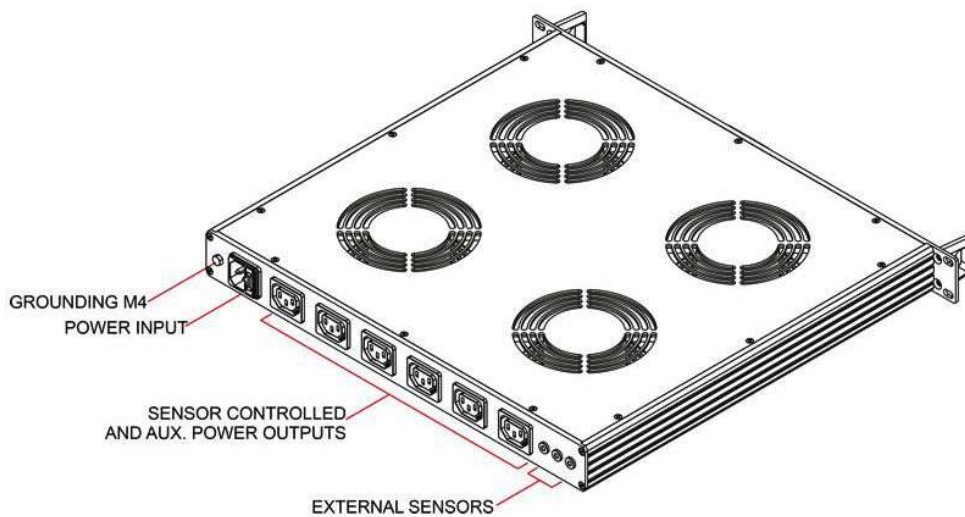

5.2.1. Grounding M4:

Connect a grounding cable with lug for M4 to the Bolt provided at the rear of the module.

5.2.2. Power Input:

Power input for Europe

- Power input 220V AC – Maximum 10A

Power input for USA, Canada

- Power input 110V AC – Maximum 20A

5.2.3. Sensor Controlled Power Outputs

- Power output 220V AC – Maximum 10 Amps all power outputs together
- Power output 110V AC – Maximum 20 Amps all power outputs together
- Each output is controlled by its corresponding sensor.
- Fully programmable via the control buttons and display at the front side of the device

5.2.4. Auxiliary Power Outputs

- Power output 220V AC – Maximum 10 Amps all power outputs together
- Power output 110V AC – Maximum 20 Amps all power outputs together
- A safety temperature can be set-up via the control panel to shut down the power to the Auxiliary power outputs when the given Maximum temperature has been reached.

6. Product Variants and configurations (Different Rear Panels)

6.1. D1000XXX - 19" Rack Mountable 4 Fans Cooling Module V1

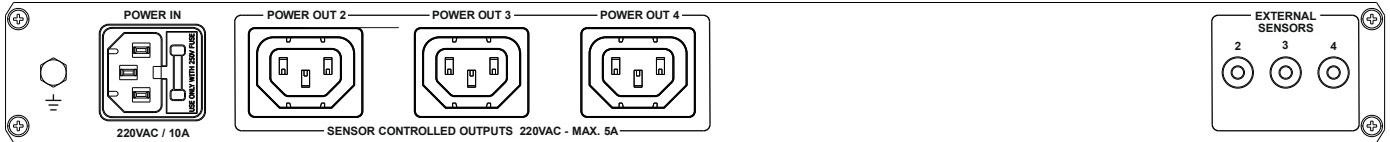

Internal Sensor	S1
External Sensors	S2, S3, S4
Internal Output	OUT1
Sensor Controlled Power Outputs 110VAC – 220VAC	OUT2, OUT3, OUT4

6.2. D1000968 – 19" Rack Mountable 4 Fans Cooling Module V2

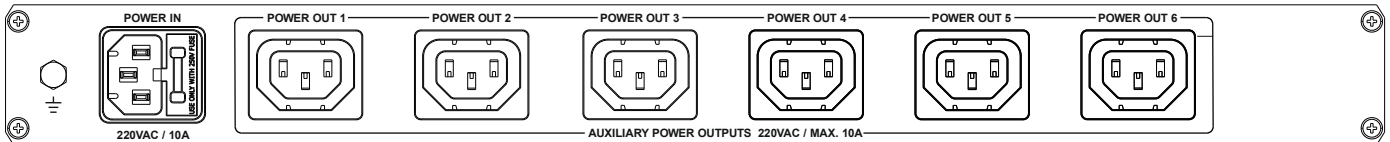

Internal Sensor	S1
Internal Output	OUT1, OUT5
Auxiliary Power Outputs 110VAC – 220VAC	6
Auxiliary Power Output Safety Temperature Setup	S5

6.3. D1000968 – 19" Rack Mountable 4 Fans Cooling Module V3

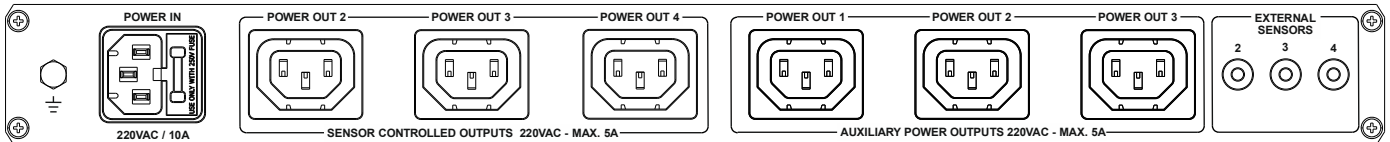

Internal Sensor	S1
External Sensors	S2, S3, S4
Internal Output	OUT1, OUT5
Sensor Controlled Power Outputs 110VAC – 220VAC	OUT2, OUT3, OUT4
Auxiliary Power Outputs 110VAC – 220VAC	3
Auxiliary Power Output Safety Temperature Setup	S5

6.4. D1000968 – 19" Rack Mountable 4 Fans Cooling Module V4



Internal Sensor	S1
Internal Output	OUT1

7. Dimensions

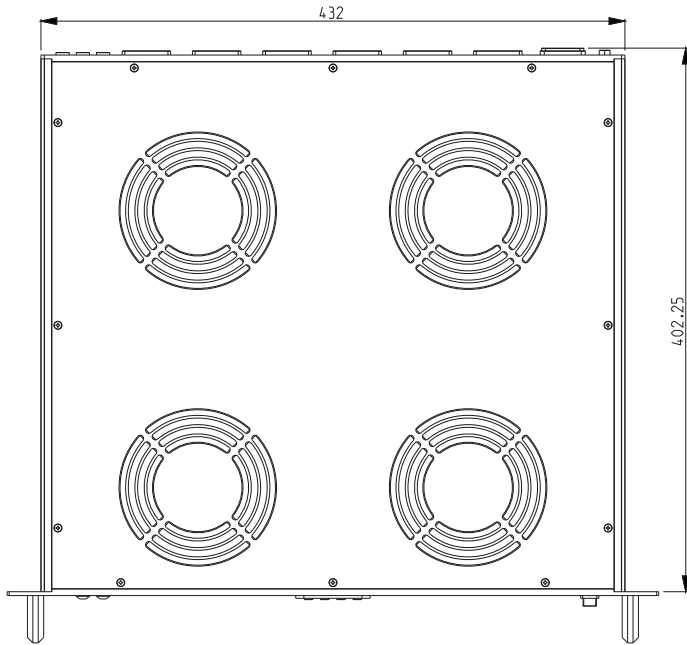
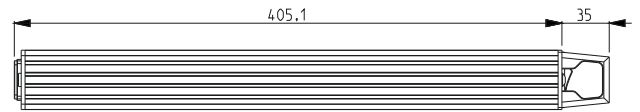
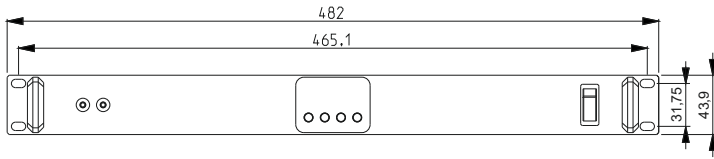

8. Installation

Place the box on a flat surface with the arrow pointing up before opening. Open the box and take out the device gently. Remove the 2 foam parts and take the device out of the bag.

Connect the grounding cable with the lug by using the M4 screw at the rear of the device.

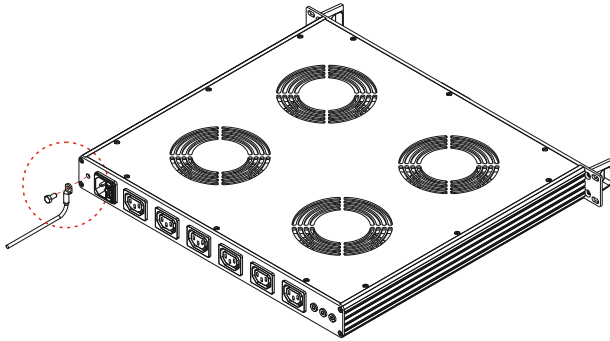

Hold the device at the correct mounting position.

Mount the 2 support brackets inside the rack at the left and right side of the device. Ensure the brackets are mounted at the correct position to obtain the best support and don't put stress on the device's front plate.

The device needs to be mounted with 4 Screws DIN912 M6 x 10 supplied in the box. Use the correct screwdriver to apply the screws. Ensure all four screws are mounted with enough torque.

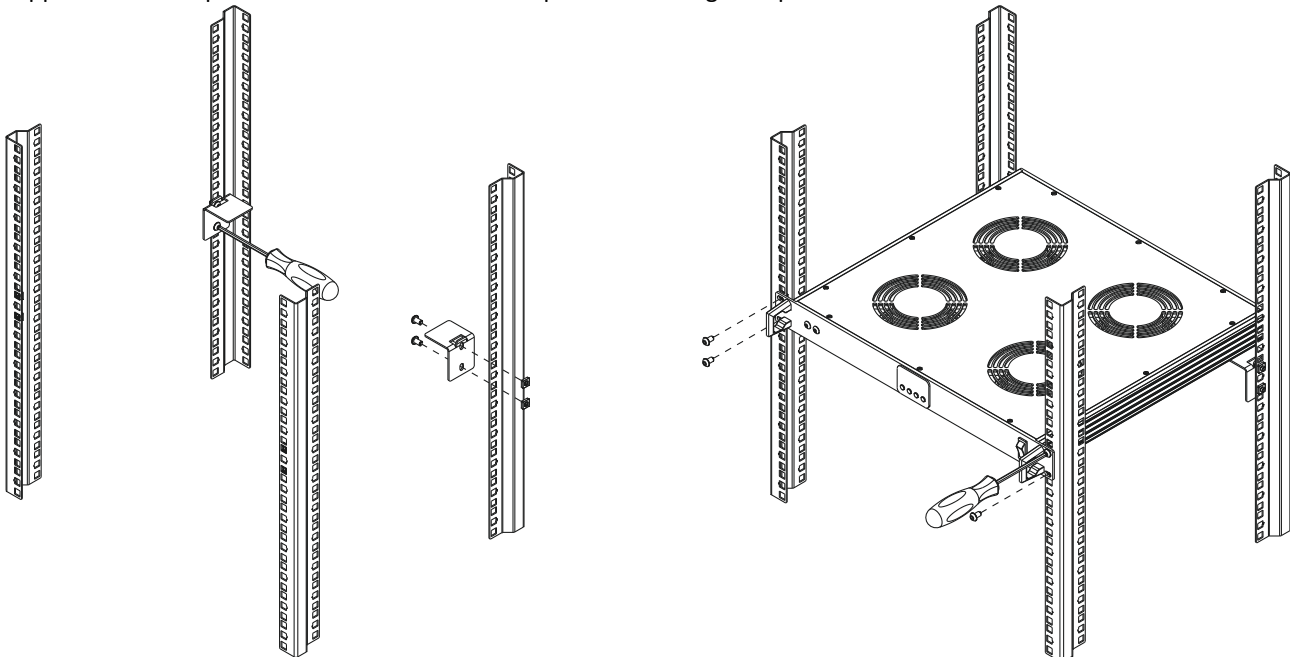

Keep A free area of minimum 1U between the 19" Rack Mountable 4 Fans Cooling Module and other devices mounted below and on top the cooling module in the rack. Close the front of the rack with 1U, 2U or 3U front plates. The 19" Rack Mountable 4 Fans Cooling Module is preferably mounted on the top position in the 19" Rack.

Always mount an Intake/Outlet plate at the **top** and **bottom** of the rack to ensure enough airflow.

Preferable airflow

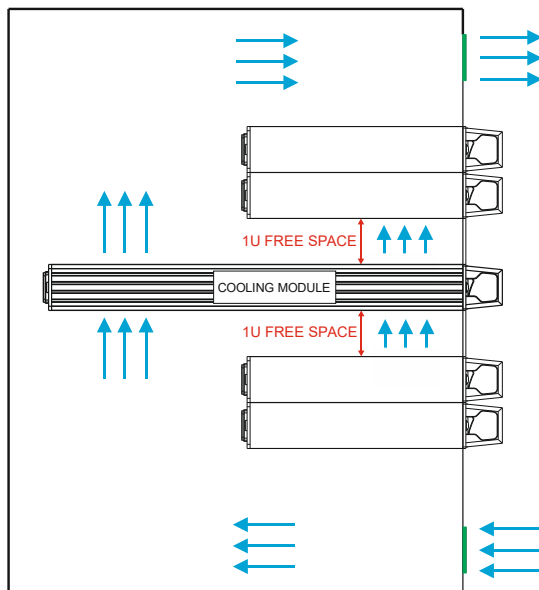

Preferable rack configuration

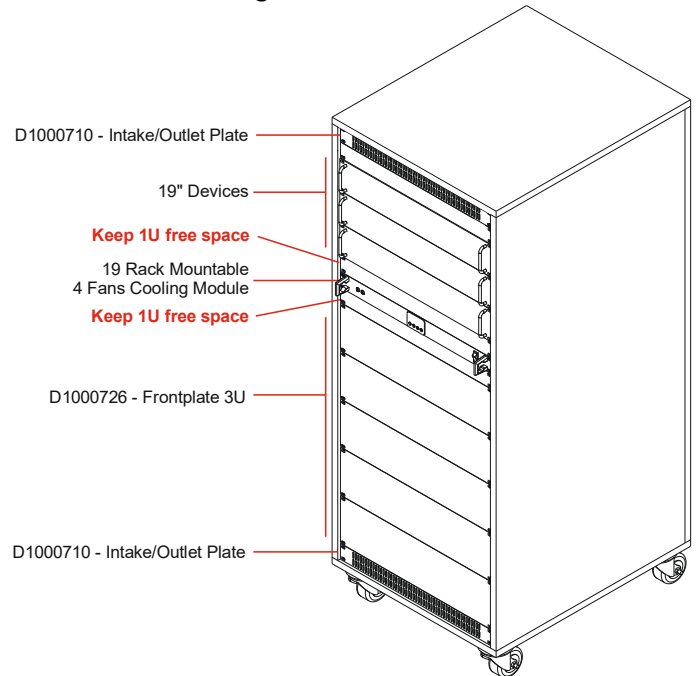



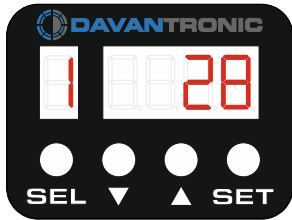

9. Programming the 19" Rack Mountable 4 Fans Cooling Module

9.1. Definitions

9.1.1. Buttons



Button 1	SELECT	
Button 2	DOWN	
Button 3	UP	
Button 4	SET (CONFIRM/SAVE)	

9.1.2. Selection mode (press SEL)

1 = Internal Sensor

2, 3, 4 = External sensors (only available with Version V1 and V3)

S = Safety Temperature: This is the maximum temperature set for any sensor (only available with Version V2 and V3)

9.1.3. Output Channels

1 = output 1: Controls the internal blowers/fans

2, 3, 4 = Controls the Sensor Controlled Power Outputs at the rear of the device 'only available with Version V1 and V3)

S = output 5: This output generally controls the relay in the 220V AC output circuit. This is the output controlled by safety Temperature Option. When the safety temperature has been reached by any sensor, the relay will be turned off.

9.1.4. Display Characters (H, L, C)

H = Highest Temperature 

L = Lowest Temperature 



COOL = Configure output for Cooling 

HEAT = Configure output for heating 

9.2. Programming the different Versions (V1, V2, V3 and V4)

9.2.1. Programming the 19" Rack Mountable 4 Fans Cooling Module V1

Turn On device:

Display shows the temperatures of the internal sensor 1 and external sensors 2,3 and 4 in a cycle. Use   to select a sensor of which to show the temperature.



A. SETUP THE SENSOR 1 WITH CORRESPONDING OUTPUT

1. Push the select button: **SEL** 

2. Select Sensor with the Arrow UP or DOWN buttons -> (1, 2, 3, 4):  

Confirm selection with: **SET** (selected sensor No. = blinking) 

3. Set High temperature with arrows UP or DOWN eg. 70°.   This is the temperature at which the fans will turn on.

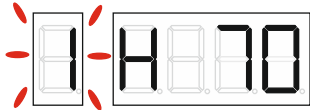

Push **SET** to confirm the High temperature of selected sensor. 

4. Set Low temperature with arrow UP or DOWN eg 50°   . This is the temperature at which the fans will turn off.

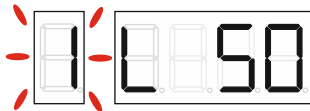

Push **SET** to confirm the Low temperature. 

Repeat for Sensors 2, 3, 4

Outputs 1, 2, 3 and 4 will turn on when the H temperature is reached and will turn off when the L temperature has been reached.

9.2.2. Programming the 19" Rack Mountable 4 Fans Cooling Module V2

Turn On device:

Display shows the temperatures of the internal sensor 1

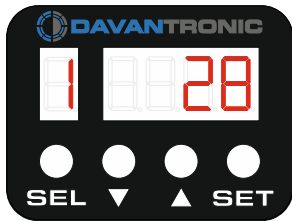

A. SETUP THE SENSOR 1 WITH CORRESPONDING OUTPUT

1. Push the select button: **SEL**

2. Select Sensor with the Arrow UP or DOWN buttons -> (1, S):

Confirm selection with: **SET** (selected sensor No. = blinking)

3. Set High temperature with arrows UP or DOWN eg. 70°. This is the temperature at which the fans will turn on.

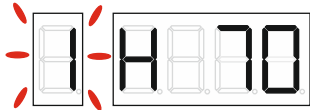

Push **SET** to confirm the High temperature of selected sensor.

4. Set Low temperature with arrow UP or DOWN eg 50°. This is the temperature at which the fans will turn off.

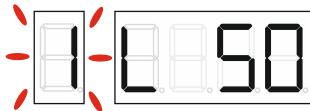

B. Setup Safety Temperature for External Power Outputs

1. Push the select button: **SEL**

2. Select S with the Arrow UP or DOWN buttons -> (1, 2, 3, 4, **S**):

3. Confirm selection with: **SET** (selected sensor S = blinking)

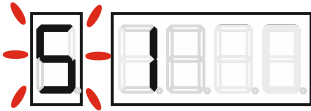
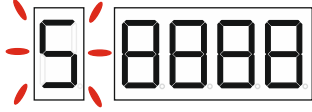

4. Select the sensor which you want to trigger the safety output to shut down using **SET**

5. Set High temperature with arrows UP or DOWN eg. 80°. This is the temperature at which the Auxiliary Power Outputs at the rear Panel of the device will be turned off.





Push **SET** to confirm the safety temperature for the selected sensor.

- Output 5 will be turned off as soon as one of the designated sensors reaches the safety temperature.
- RED LED will blink when Output 5 turns OFF.
- Buzzer will sound when Output 5 turns OFF.

9.2.3. Programming the 19" Rack Mountable 4 Fans Cooling Module V3



Turn On device:

Display shows the temperatures of the internal sensor 1 and external sensors 2,3 and 4 in a cycle. Use   to select a sensor of which to show the temperature.



A. SETUP THE SENSOR 1 WITH CORRESPONDING OUTPUT

5. Push the select button: **SEL** 

6. Select Sensor with the Arrow UP or DOWN buttons -> (1, 2, 3, 4):  

Confirm selection with: **SET** (selected sensor No. = blinking) 

7. Set High temperature with arrows UP or DOWN eg. 70°.   This is the temperature at which the fans will turn on.

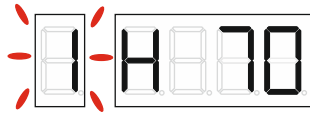

Push **SET** to confirm the High temperature of selected sensor. 

8. Set Low temperature with arrow UP or DOWN eg 50°   . This is the temperature at which the fans will turn off.

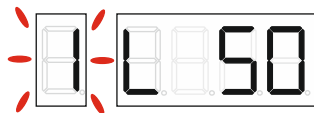

Push **SET** to confirm the Low temperature. 

Repeat for Sensors 2, 3, 4

Outputs 1, 2, 3 and 4 will turn on when the H temperature is reached and will turn off when the L temperature has been reached.

B. Setup Safety Temperature for External Power Outputs

1. Push the select button: **SEL**

2. Select S with the Arrow UP or DOWN buttons -> (1, 2, 3, 4, S): ▼ ▲

3. Confirm selection with: **SET** (selected sensor S = blinking)

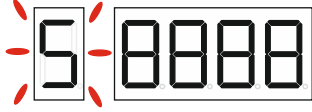

4. Set High temperature with arrows UP or DOWN eg. 80°. ▼ ▲ This is the temperature at which the Auxiliary Power Outputs at the rear Panel of the device will be turned off.



Push **SET** to confirm the Safety Temperature.

- Output 5 will be turned off as soon as one of the designated sensors reaches the safety temperature.
- RED LED on front panel of the device will blink when Output 5 turns OFF.
- Buzzer will sound when Output 5 turns OFF.

9.2.4. Programming the 19" Rack Mountable 4 Fans Cooling Module V4

Turn On device:

Display shows the temperatures of the internal sensor 1

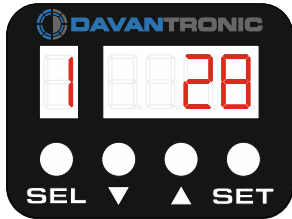

A. SETUP THE SENSOR 1 WITH CORRESPONDING OUTPUT

1. Push the select button: **SEL**

2. Select Sensor with the Arrow UP or DOWN buttons -> (1, S):

Confirm selection with: **SET** (selected sensor No. = blinking)

3. Set High temperature with arrows UP or DOWN eg. 70°. This is the temperature at which the fans will turn on.

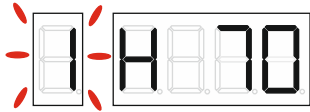

Push **SET** to confirm the High temperature of selected sensor.

4. Set Low temperature with arrow UP or DOWN eg 50°. This is the temperature at which the fans will turn off.

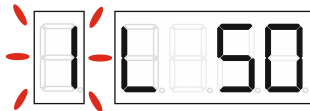

10. LED Indicators

GREEN LED = Device works normally. Temperature below safety temperature

RED LED Blinking = Safety temperature reached; Power output turned OFF

11. Buzzer

Buzzer beeping: Safety Temperature has been reached; Power output turned OFF.

12. Trouble Shooting

When tuned on properly the device should start operating. The green LED lights up at the front of the device. The fans will turn on when the configured temperatures have been reached.

Device does not turn on after switching the ON/OFF switch:

- Check if the power cable is correctly installed. *Install the cable in a proper way.*
- Verify that the power cable is not damaged and works well. *If the power cable is damaged, replace the cable with a new cable.*
- Verify the Fuse at the rear of the device next to the power input connector. *If the fuse is burned, replace the fuse.*
- If none of the above solves the problem, contact your supplier.

Red LED is turned on, Green LED is turned off:

- One of the configured sensors reached the given High Temperature. The red LED will turn off as soon as the temperature is equal or lower than the Low temperature of that given sensor. At the same time the Green LED will turn back on.

Red LED is Blinking, Green LED is turned off:

- Usually, the red LED starts blinking when the safety temperature of the designated sensor has been reached. At the same time the Auxiliary power outputs at the rear of the device will be powered off. This is the safety feature of the device. *Turn off the device. Verify what caused the temperature to reach the configured Safety temperature. After solving the issue or when decided there was no issue, turn the device back on. The device will start working as configured.*

Auxiliary Power Outputs turned off:

- Usually, the auxiliary power outputs will turn off when the safety temperature of the designated sensor has been reached. At the same time the red LED at the front of the device will start blinking. This is the safety feature of the device. *Turn off the device. Verify what caused the temperature to reach the configured Safety temperature. After solving the issue or when decided there was no issue, turn the device back on. The device will start working as configured.*

13. Technical Specification

Dimensions	Width 482mm x depth 440mm x height 43,9mm
Weight (device)	4.1 Kg
Weight (device with packing)	5.5 Kg
Mounting	19" Rack Mount
Power Input	110 V AC (20 AMPS) / 220 V AC (10 AMPS) ~50/60Hz
Power Output	110 V AC (20 AMPS) / 220 V AC (10 AMPS) ~50/60Hz
Power Input Plug	EC 320 C20 Female
Power Output Plug	EC 320 C20 Male
Air Flow	7.2M2/min. ~ 252CFM
Material	Aluminum
Finish	Sand Blasted, Anodized
Color	Black
Operating Temperature	0°C to +55°C
Storage temperature	-20°C to +55°C
Internal Sensor Type	NTC
External Sensor Type	NTC
IP Rating	IP43
Noise	57 dB-A

15. Environmental and Recycling

The 19" Rack Mountable 4 Fans Cooling Module meets all RoHS and REACH regulations.

16. Packaging

Packaging consists of PE foam and cardboard.

18. Power Cords

AC power cords If supplying your own power cord, you must meet several specifications. Table 16. Power cord specifications

Country	Cord Type	Plug (AC Source)	Socket (device)	Comments
USA	SJT or SVT, 12 AWG minimum, 3 conductors	EC 320 C20, 250V, 20A or a suitable plug rated 250V, 20A	IEC 320 C19, 250V, 20A	Must be UL certified
EUROPE	Harmonized, H05-VVF-3G2.5	EC 320 C20, 250V, 16A or a suitable plug rated 250V, 16A	Standard Power Extension Cord, 10A, 18AWG (IEC-320-C19 to IEC-320-C14).	

Important: The plug and the complete power cord assembly must meet the standards appropriate to the country and must have safety approvals acceptable in that country.

20. Optional Products.

Product Number	Description
D1000729	Front Plate Aluminum 1U
D1000728	Front Plate Aluminum 2U
D1000726	Front Plate Aluminum 3U
D1000710	Front Plate Intake/Outlet 1U
D1000711	Front Plate Intake/Outlet 2U
D1000659	Front Plate Intake/Outlet 3U
D1001048	External NTC Sensor with 1m Cable
D1001049	External NTC Sensor with 1.5m Cable
D1001050	External NTC Sensor with 2m Cable
D1001051	External NTC Sensor with 4m Cable

21. Warranty

This warranty program is our commitment to you, the original purchaser, that each product sold by Davantronic will be free from defects in manufacturing for a period of two years from the date of purchase. If a product is found to have a defect in material or workmanship, we will take the appropriate actions defined in this warranty to resolve any issues. The warranty program applies to any order, purchase, receipt, or use of any products from Davantronic. The program covers products that have become defective, malfunctioned, or expressly if the product becomes unusable. The warranty program goes into effect on the date of purchase. The program will expire two years from the date of purchase. If your product becomes defective during that period, AC Infinity will replace your product with a new one or issue you a full refund. The warranty program does not cover abuse or misuse. This includes physical damage, submersion of the product in water, incorrect installation such as wrong voltage input and misuse for any reason other than intended purposes. Davantronic is not responsible for consequential loss or incidental damages of any nature caused by the product. We will not warrant damage from normal wear such as scratches and dings.

Thank you for choosing Davantronic. We are committed to product quality and friendly customer service. If you have any questions or suggestions, please don't hesitate to contact us. Visit www.davantronic.com and click **contact us** for our contact information.

Copyright © 2023 Davantronic all rights reserved.